



Texas School for the Blind and Visually Impaired
Outreach Programs

www.tsbvi.edu | 512-454-8631 | 1100 W. 45th St. | Austin, Texas 78756

Resonance Board Design and Little Room Configurations

Reprint of handout developed

With the approval of Dr. Lilli Nielsen

The Resonance Board

Developed by Lilli Nielsen

The resonance board is made from 4 mm plywood, 150 cm x 150 cm. Along the edge of the underside attach a wooden strip 2 cm x 2 cm. IT IS VERY IMPORTANT TO APPLY THE STRIP ALONG THE EDGE AND THAT THE STRIP IS NOT WIDER THAN 2 CM. Using American lumber products by a 4 ft. x 8 ft. sheet of ¼ inch plywood (paneling) and cut it to 4 ft. x 4 ft. or 4 ft. x 6 ft. **Birch plywood** is recommended. For the lip under the plywood buy a 1 x 2 and have it custom cut to 2 cm (approximately ¾ in.). Please note that only one piece of plywood is used. The bottom of the resonance board is open. The scraps of plywood can be used to make a small resonance board or low tables.

If the board is correctly made the sounds which the child produces on the sounding board will be transmitted through the wood to all parts of the child's body which are in contact with the board. The sounds will have a prolonged and reinforced effect which is important to motivate increased activity by the child. The weight of the child will cause the board to bend downwards slightly. This will make beads and balls roll back toward the center when the child's body movements move them towards the edge of the board. This is an example of the prolonged reaction to the child's activities.

The air space under the resonance board has an insulating effect on a cold floor. Because of its flexibility, children and adults do not become tired from sitting on the board.

The child will have an opportunity to develop an understanding of space by learning about the limited space which the resonance board represents. When the child starts to move about on the board he/she will develop a good basis for motivation to use the space beyond the resonance board. This will allow him/her to start moving from place to place.

When using the resonance board for the first time, an adult should sit on the board with the child between her legs. The adult plays with objects to make small sounds on the board. When the child initiates communication with the adult (by looking at the adult, changing body position, etc.) the adult responds by talking softly about their play. The adult limits talking to the child to times when the child is not actively engaged in learning. The adult continues to make sounds which are a little louder, and by and by moves the child's body directly on to the board. Not until then, when you have made sure the child feels secure and is made to feel at home in the situation, do you start putting objects around the child, under his hands, feet and head. By observing the child's reactions you will be able to decide how long the session should last, when the child is able to lie on the board alone and for how long.

Cover board with water-based clear acrylic so you can wipe it off

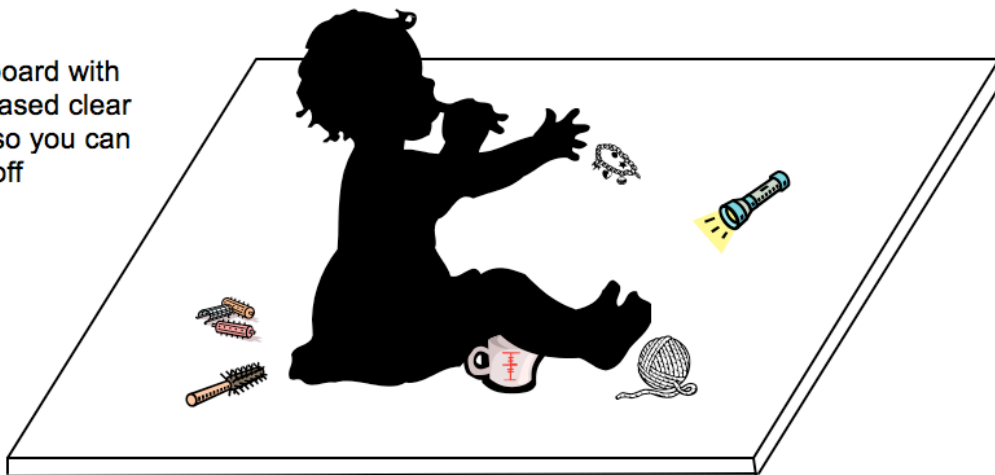

Little Room Configurations

From Space and Self, By Lilli Nielsen, Page 4

These numbers are in centimeters. 30 cm = 1 foot and 60 cm = 2 feet.

The plexiglass top should never exceed 2 feet x 2 feet.

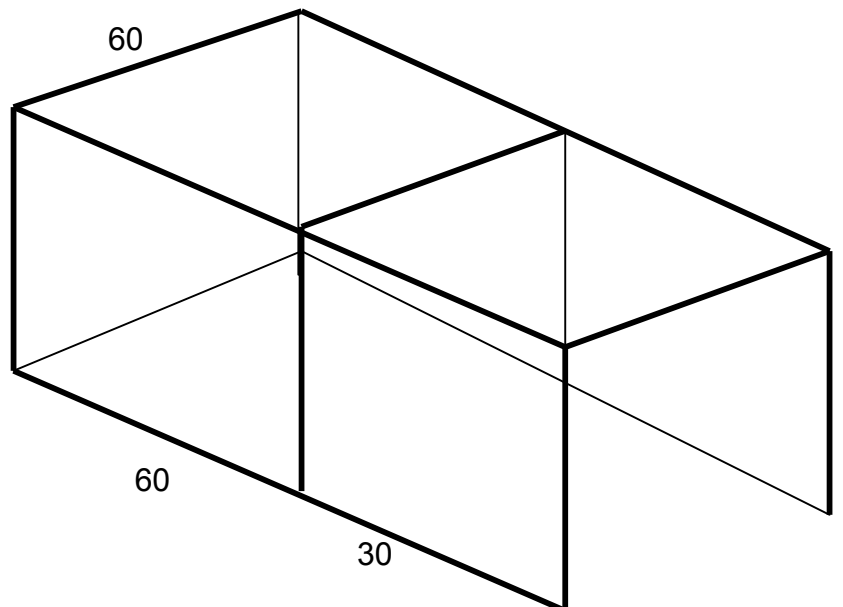
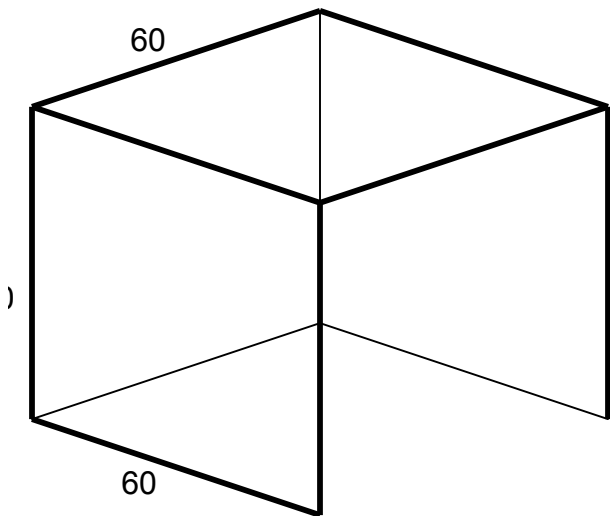
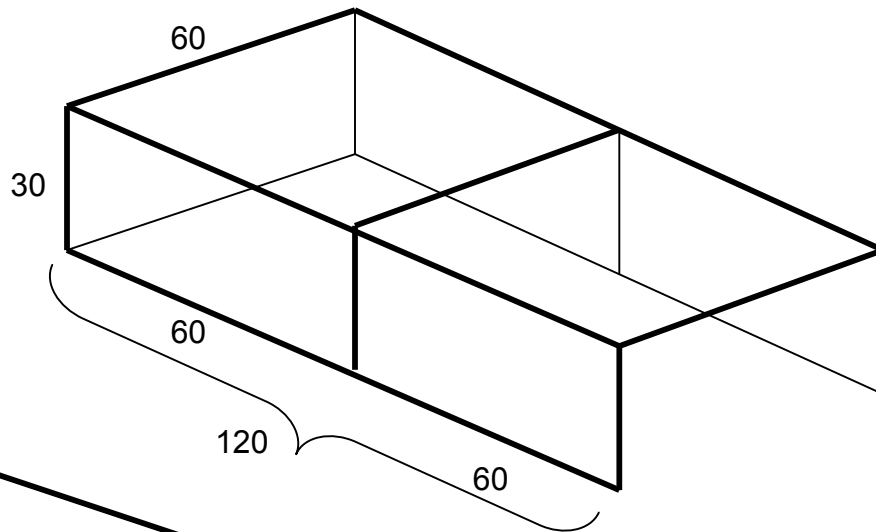
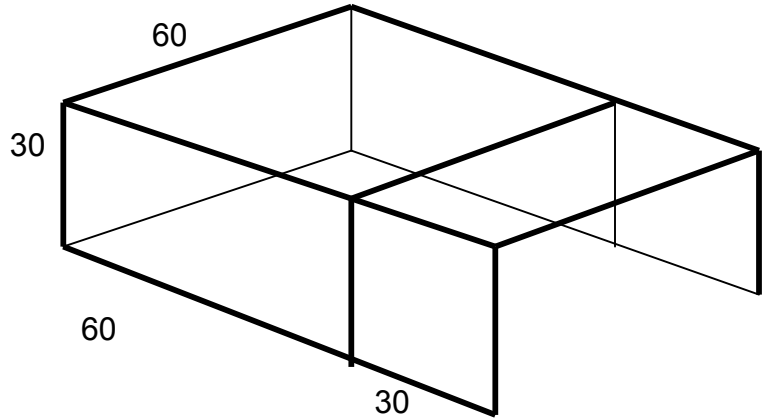
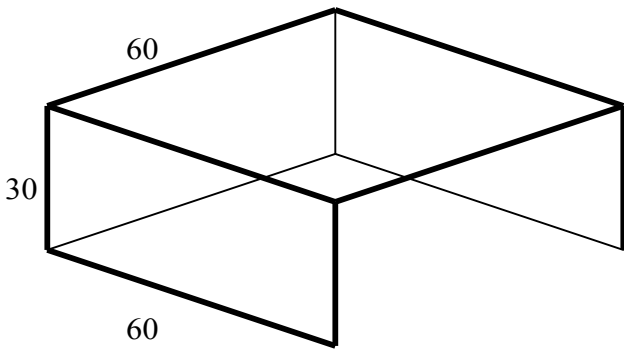

Texas School for the Blind and Visually Impaired Outreach Programs



Figure 1 TSBVI Logo



"This project is supported by the U.S. Department of Education, Office of Special Education Programs (OSEP). Opinions expressed herein are those of the authors and do not necessarily represent the position of the U.S. Department of Education.

Figure 2 IDEA logo